

# FISCHBEIN®

## Model PBC 6000™

Pinch Bag Closer

## Fischbein Model PBC 6000™

The Fischbein Model PBC 6000™ is a heavy duty sealer producing sift resistant bag closure for a wide array of product from food additives and pet food, to pesticides and fertilizers in pinch style paper bags. A variable speed, direct drive system provides greater production on automated lines, sealing up to 75 linear feet per minute. A patented breakaway design eliminates costly downtime caused by bag jams, while allowing easier access for cleaning and service.



**EVERYTHING** IN BAGGING EQUIPMENT™



# Fischbein® Model PBC 6000™

## Pinch Bag Closer

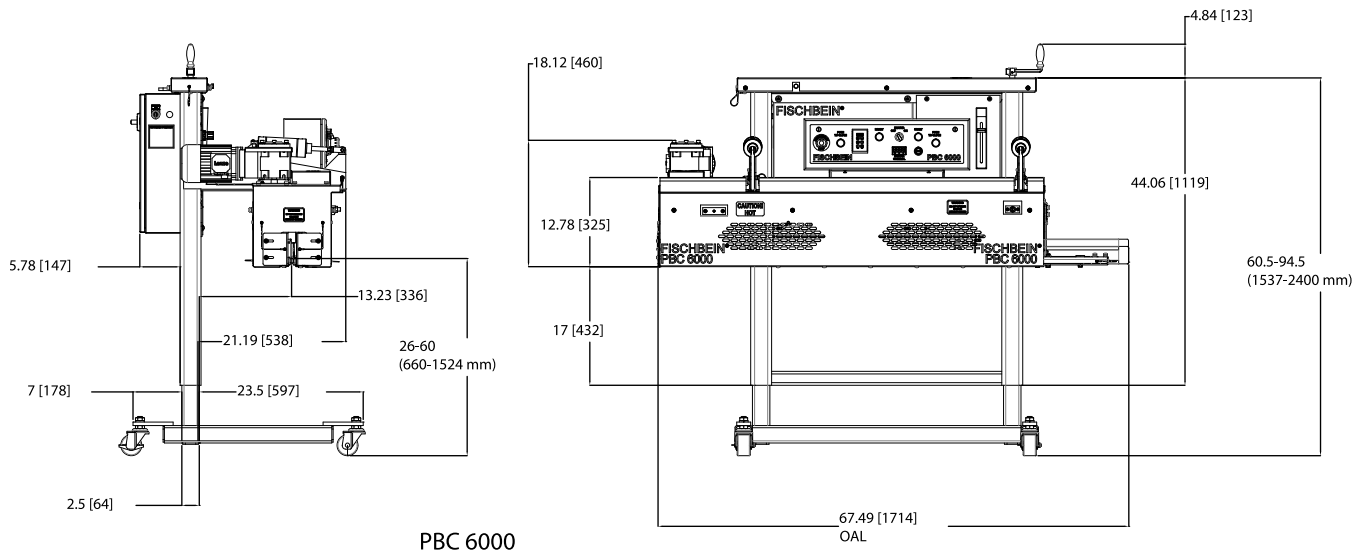

### FEATURES

#### BAG TYPES

Seals a variety of pre-glued multi-wall, paper pinch-style bags.

#### BREAKAWAY DESIGN

#### LOW MAINTENANCE

The patented breakaway design eliminates costly downtime caused by bag jams while allowing easy cleaning and service of the hot-air manifold and bag folder.

#### SIFT RESISTANT CLOSURES

Makes it perfect for powders and granulated chemicals, pesticides fertilizer, pet-food and food products.

#### USER FRIENDLY CONTROLS

Safe and easy to use control panel with digital temperature display, key pad for variable speed control, and dual emergency stop buttons.

### OPTIONS

- Left to right operation
- Reverse fold - rear direction
- Extended infeed for automation applications
- Additional motor starter and contactor for conveyor
- CR Plus 2 part corrosion resistant powder coat finish
- Stainless steel NEMA 4 X washdown version
- 575 VAC

### SPECIFICATIONS

- Dimensions: W 68 in (172.7 cm), D 33 in (83.8 cm), H 72 in (182.9 cm)
- Speed: Up to 75 linear feet per minute
- Electric (NEMA 12): 230/380/460V-3PH-60Hz, 24 VAC
- Air: 7 cfm @ 90 PSI

### BAGS

- Bag Types: Multi-wall paper pinch-style bags with pre-applied glue.
- Gussets: Any size including flat bags
- Free Bag Top: Minimum 6 in (15.2 cm)

### APPLICATIONS

- Bakery Mixes
- Minerals
- Pet Food
- Feed Additives
- Fertilizers
- Agricultural Seed
- Chemicals
- Cat Litter
- Powdered Dairy Products
- Flour

**704-871-1159**

**HAMER  
FISCHBEIN®**

A DURAVANT COMPANY

Specifications are subject to change without notice.

